

QUICK START :

1. Connect the safety valve at the inlet of Water Heater in supplied separately. Dont install Water Heater without safety valve.
2. Hook the Water Heater on wall with the help of mounting brackets. Take necessary dimensions for making holes for mounting brackets.
3. Connect the inlet & outlet piping as marked on Water Heater.
4. Start water flow inside Water Heater & fill it completely till water comes out from outlet connection.
5. Connect the electrical cord to power point.
6. Switch on the Water Heaters main supply, the red indicator lamp comes on.
7. The red indicator lamp switches off and indicates water inside the Water Heater has reached the set temperature.
8. Run a complete cycle of Thermostat ON to Thermostat cut OFF, in presence of service provider/ Installation Technician/Plumber.



INSTRUCTION MANUAL

Platinum NXT



Ariston Group India Private Limited

Office No: 103, 1st Floor, Mayfair Tower, Wakdevadi, Shivaji Nagar, Pune - 411005, Maharashtra, India.

Customer care number:
020 6734 2288, +91 8600 25 6000 | 7362 888 999

Email: customer.care@racold.com

- General Safety Instruction
- Technical Characteristics
- Maintenance Regulation

- Water Heaters Description
- Installation Norms
- Useful Information

Dear Customer,

Thank you for choosing a world - class product from Ariston Group India Private Limited. Your choice for nothing but the best is reflected by your trust placed in Ariston.

Racold is registered trademark of Ariston Spa, Italy.

Ariston Group India Private Limited is a fully owned subsidiary of Ariston Spa, Italy and part of the Ariston Group-the leaders in Water Heater.

Ariston Group India Private Limited is the largest provider of water heating solutions in India, catering to all sectors of water heating namely Electrical, Gas, Solar and Heat Pump Water Heaters.

The Racold range of products from Ariston Group India Private Limited has changed the industry standards by setting new benchmarks in quality, aesthetics and performance.

Our many firsts in India include:

Water Heater with rust proof polypropylene body.

Stainless steel inner container with multi-function safety valve for high pressure operation without additional pressure reducing valve.

PUF insulation for maximum energy saving.

Energy labeling for any domestic electrical appliances.

Only Water Heater with quality and performance certification as per IEC/EN and Indian Standards (ISI mark).

Won the highest number of National Energy Conservation awards from BEE (Bureau of Energy Efficiency) for the Electric Storage Water Heaters category.

Retain this manual safely and in case you need any assistance you may get in touch with any of our customer care centres, the details of which are enclosed.

Kindly follow the instructions given in this manual and enjoy years of trouble free performance.

ARISTON GROUP INDIA PRIVATE LIMITED

REBORN EVERYDAY WITH HOT WATER





GENERAL SAFETY INSTRUCTIONS

CAUTION!















1. This manual constitutes an integral and essential part of the product. It must be stored with care and must always accompany the appliance, even when the latter is transferred to another owner or user and/or is installed on another system.
2. Carefully read the instructions and warnings contained in this manual; they provide important information for safe installation use and maintenance of your new appliance.
3. The installation and initial start-up of the appliance must be performed by qualified personnel in compliance with the national regulations in force regarding installation, and in conformity with any regulations issued by local authorities and public health bodies. At all events, prior to accessing the terminals, all the supply circuits must be disconnected.
4. It is forbidden to use this appliance for uses other than those specified. The manufacturer shall not be held liable for any damage due to improper, incorrect and unreasonable use or due to failure to comply with the instructions set forth herein.
5. Incorrect installation can cause personal injury, property damage and harm to animals; the manufacturer shall not be held liable for such consequences.
6. Keep all packaging material (clips, plastic bags, expanded polystyrene, etc.) out of reach of children, as it may be potentially dangerous.
7. The appliance can be used by children older than 8 years and by people with reduced physical, sensory or mental abilities, or who lack adequate experience and knowledge, provided they are supervised or have been instructed on how to safely use the appliance and on the potential risks pertaining to it. Children must not play with the appliance. Any cleaning and maintenance activities performed by the user must not be effected by unsupervised children.
8. It is forbidden to touch the appliance with bare feet or with wet body parts.
9. All repairs, maintenance, plumbing and electrical connections should be performed exclusively by qualified personnel, using original spare parts only. Failure to comply with the above instructions could compromise Safety and will exempt the manufacturer from all liability.
10. The temperature of the hot water is adjusted by an operating thermostat, which also functions as a resettable safety device so as to avoid dangerous increases in the temperature level.
11. The electrical connection of the appliance should be performed in accordance with the instructions provided in the relevant paragraph.
12. If the appliance is equipped with a power supply cable, always contact an authorised technical assistance centre or qualified personnel whenever it needs to be replaced.
13. Do not tamper with the pressure safety device, if supplied with the appliance; operate it regularly to verify that it is not clogged and remove any limescale deposits.
14. It is normal for water to trickle from the pressure safety device. For this reason, it is necessary to connect the outlet which must always be left exposed to the atmosphere to a drainage pipe that slopes downwards and towards an area not subject to frost.
15. The appliance must be drained if left inactive in a room subject to frost.
16. Hot water running from taps at temperatures above 50°C may immediately cause serious burns. Children, the disabled and the elderly run a greater risk in this regard. It is therefore advisable to use a thermostatic mixing valve connected to the appliances water outlet pipe, identified by a red collar.
17. No flammable items should be left in contact with or in the vicinity of the appliance.



SYMBOL LEGEND:

Symbol	Description
	Failure to observe this warning may lead to injury even fatal in certain circumstances to people.
	Failure to observe this warning may lead to damage even serious in certain circumstance to objects, plants or animals.
	It is mandatory to comply with the general and appliance-specific safety measures.

GENERAL SAFETY INSTRUCTIONS

Ref.	Warning	Type of risk	Symbol
1	Do not perform operations that imply opening the appliance and removing it from its installation points.	Electrocution due to exposure to live components. Personal injury from burns due to overheated components or wounds caused by sharp edges protrusions.	
2	Do not start or stop the appliance simply by plugging it into the electricity mains supply or unplugging it.	Electrocution from a damaged cable or plug, or socket.	
3	Do not damage the power supply cable.	Electrocution from live unsheathed wires.	
4	Do not leave anything on top of the appliance.	Personal injury from an object falling off the appliance following vibrations.	
		Damages to the appliance or any objects underneath it due to the object falling off following vibrations.	
5	Do not climb onto the appliance.	Personal injury due to the appliance falling.	
		Damage to the appliance or any objects underneath it due to the appliance falling off from its place of installation.	
6	Do not attempt to clean the appliance without first turning it off and unplugging it or switching the dedicated switch off.	Electrocution through exposure to live components.	
7	Install the appliance on a solid wall that is not subject to vibrations.	Falling of the appliance due, to collapse of the wall or noise during operation.	
8	Make all electrical connections using conductors with a suitable section.	Fire caused by overheating due to electrical current passing through undersized cables.	
9	Reset all the safety and control functions affected by any interventions performed on the appliance and make sure they operate correctly before re-using the appliance.	Damage or shutdown of the appliance due to out-of-control operation.	
10	Before handling, empty all components that may contain hot water, carrying out any bleeding if necessary.	Personal injury from burns.	
11	Descal the components, in accordance with the instructions provided on the safety data sheet of the product used, airing the room, wearing protective clothing, avoid mixing different products, and protect the appliance and surrounding objects.	Personal injury due to contact of the skin or eyes with acidic substances, inhalation or swallowing of harmful chemical agents.	
		Damage to the appliance or surrounding objects due to corrosion caused by acidic substances.	
12	Do not use any insecticides, solvents or aggressive detergents to clean the appliance.	Damage to the plastic and painted parts.	



Please fill in the following details:

Product: ELECTRIC STORAGE WATER HEATER

Model No : _____

Serial No: _____

Purchaser's Name & Address: _____

Dealer's Name & Address: _____

Dealer's Signature: _____

Cash Memo No: _____

Date of Purchase: _____

The Racold Water Heater comes with warranty period of 2 years from the date of purchase against electrical breakdown or mechanical failure caused through defective material and workmanship. The inner container has warranty of 7 years and the heating element has a warranty period of 3 years. In event of failure covered by this warranty, you are requested to contact our customer care and obtain the complaint number. Our trained technicians will repair the product at our option. No further liability for the consequential or damage in accepted or implied. We will not be responsible for any human injury, property damages and consequential damages caused due to improper use. All disputes will be subjected to Pune jurisdiction only.

Warranty on the tank and heating element applies only if:

1. Annual check of anode is done mandatorily and its replacement done in case of consumption (rod diameter less than 7 mm.)
2. Warranty will be no more valid in case the maintenance of anode is not done as per point no 1

Following things shall not be covered under warranty:

- 1) Any plumbing and/or electrical related problems
- 2) Any defects arising due to wrong and/or non-recommended installation procedure
- 3) Dry heating of water Heater
- 4) Consumables such as anode
- 5) Any human injury, property damages and consequential damages caused due to improper use

It is recommended to install the product through the authorized service centre.

Please check instruction Manual or our website for the customer care contact number.



USER INSTRUCTIONS



CAUTION! Follow the general warnings and the safety norms listed at the beginning of the text and keep to all the instructions given under all circumstances.

Advice for user

- Avoid positioning any objects and /or appliances that could be damaged by water leaks beneath the water heater.
- should you not use any water for an extended period of time, you should:
 - Disconnect the appliance from the electrical supply by switching the external switch to OFF
 - Turn off the plumbing circuit taps.
- Hot water at above 50°C Flowing out of the taps at the point of use could cause serious scalds or even death from burns.

Children, the disabled and the elderly are more exposed to the risk of burns.

It is strictly forbidden for the user to perform any routing or extraordinary maintenance.

Operation and Regulation of the operating temperature

Start -up

To start the water heater, press on the switch, the pilot lamp (fig.1) will stay during heating.

Working temperature control

Set the temperature with the step-less temperature regulator

USEFUL INFORMATION

If the water comes out cold, have the following checked:

- The thermostat is powered
- The heating parts of the heating element

If the water comes out boiling hot (steam in the taps)

Disconnect the appliance from the electricity supply and have the following Checked:

- The thermostat
- The amount of limescale build- up in the tank and on the heating element

If the hot water delivery is insufficient, have the following checked:

- The pressure of the water mains
- The condition of the deflector on the cold water intake pipe
- The condition of the hot water pipe
- The electrical components

Water trickling from the pressure safety device

During the heating phase, some water may trickle from the tap. This is normal. To prevent the water trickling, a suitable expansion vessel must be installed on the flow system. If the trickling continues even after the heating phase, have the following checked:

- Device calibration
- The pressure of the water mains

Caution: Never obstruct the appliance outlet!

IT IS RECOMMENDED TO INSTALL THE PRODUCT THROUGH THE AUTHORIZED SERVICE CENTRE.

The data and specification indicated are not binding and the producer reserves the right to carry out any modifications that may be required without prior notice or replacement.

This product is in conformity with REACH regulations.

MAINS CORD:

- 3 Core X 1.5 Sq. mm (48/0.2) PVC Sheathed core with ISI certified for Platinum NXT (3Kw) models

ELECTRICAL CONNECTION:

Refer below wiring diagram, to check electrical connections. Ensure proper earthing at 3pin supply point.

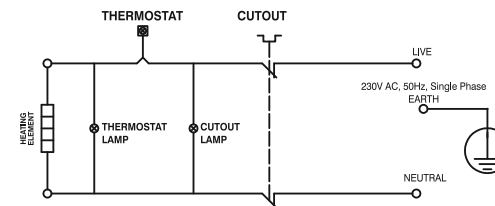

Note: Main's cord or any other electrical component must be repaired /replaced by authorized service personnel only. Minimum Contact separation of 3mm is required in all poles for disconnection.

PLASTIC CONNECTOR ASSY INSTRUCTIONS :

VERTICAL PRODUCT

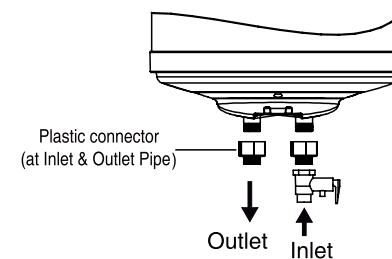

HORIZONTAL PRODUCT

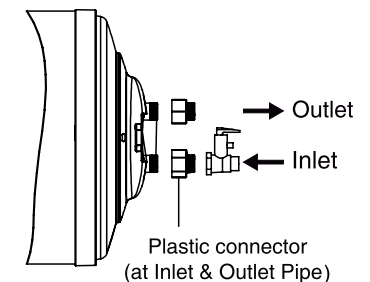

NOTES :

1. Polybag containing plastic connector/s and sealing washer/s placed in Thermocol packaging.
2. Recommended to use plastic connector/s to avoid thermal loss for better energy savings.

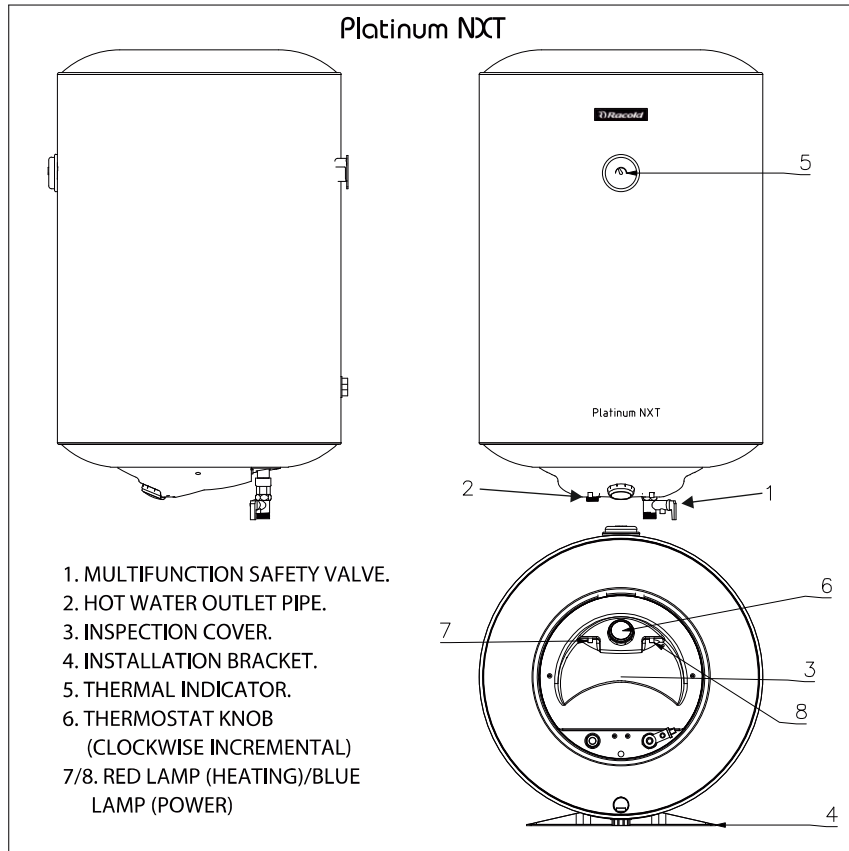

EN

TECHNICAL CHARACTERISTICS

For the technical characteristics of the appliance, please refer to the information provided on the data plate (label located near the water inlet and outlet pipes).

Platinum Model	Platinum NXT					
	50V	50H	70V	70H	100V	100H
Model Capacity / Installation	50.4	50.2	70.3	70.1	100.5	100.3
Real Capacity (Litrs)	50.4	50.2	70.3	70.1	100.5	100.3
Power Supply	230 Volts AC / 50 Hz / Single Phase					
Wattage (kW)	3 kW					
Reheating time for 50° C temp rise (Min) Max	70		100		150	
Mean hot water output temp (°C) Min	60° C	50° C	60° C	50° C	60° C	50° C
Mixing Factor % (Max)	30%		30%		30%	

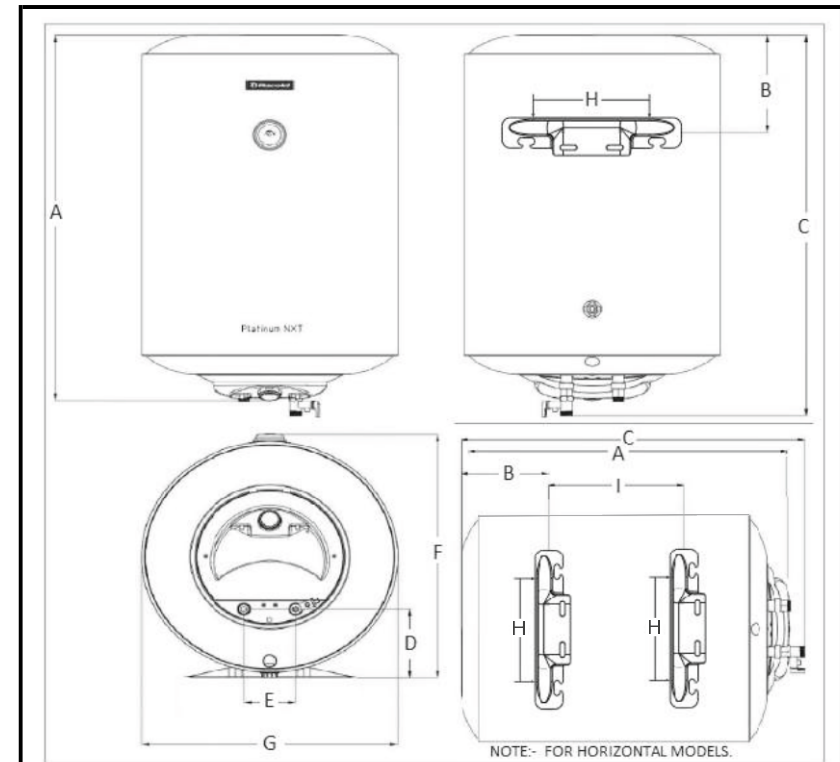

Model	Platinum NXT		
	50 LTR	70LTR	100LTR
A	632	806	1039
B	180	210	229
C	666	820	1076
D	163	163	163
E	100	100	100
F	521	521	521
G	496	496	496
H	239	239	239
I	143	300	535
PIPE	G1/2"	G1/2"	G1/2"

"NOTE ALL ABOVE DIMENSIONS ARE IN MM"