

## INSTRUCTION MANUAL

CDR Dlx Plus

CDR PR

CDR Dlx

CDP

CDR Swift

Buono Pro

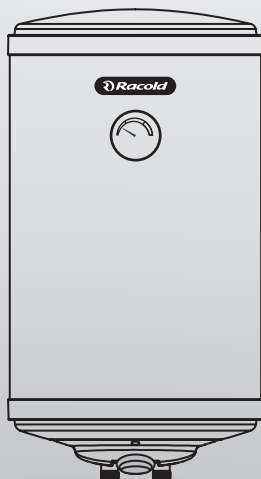

CDR Dlx Plus



CDR Dlx/ CDR Swift/CDR PR  
CDP/Buono Pro

- Product Features
- Safety Devices
- Installation

- Know Your Water Heater
- Specifications
- Electrical Connections

Dear Customer,

Thank you for choosing a world-class product from Ariston Group India Private Limited.

Your choice for nothing but the best is reflected by your trust placed in Ariston.

Racold is registered trademark of Ariston Spa, Italy. Ariston Group India Private Limited is a fully owned subsidiary of Ariston Spa, Italy and part of the Ariston Group the leaders in water heater.

Today Ariston Group India Private Limited is the largest provider of water heating solutions in India, catering to all sectors water heating namely “Electrical, Gas, Solar and Heat Pump water heaters”

The Racold range of products from Ariston Group India Private Limited have changed the industry standards by setting new benchmarks in quality, aesthetics and performance.

### **Our many firsts in India include:**

- Water heater with rust proof polypropylene body.
- Stainless steel inner container with multi-function safety valve for high Pressure operation without additional pressure reducing valve.
- PUF insulation for maximum energy saving.
- Energy labeling for any domestic electrical appliances.
- Only water heater with quality and performance certification as per IEC/EN and Indian standards (ISI mark).
- Won highest number of National Energy Conservation Award from BEE

(Bureau of Energy Efficiency) for electric storage water heaters.

Retain this manual safety and in case you need any assistance you may get in touch with any of our customer care centers, the details of which are enclosed.

Kindly follow the instructions given in this manual and enjoy years of trouble free performance.

**ARISTON GROUP INDIA PRIVATE LIMITED**

## PRODUCT FEATURES:

1. High density PUF insulation.
2. Rustproof polypropylene top, bottom & inspection cover with non-corrosive body.
3. Hi-tech thermostat and cutout for double safety
4. Titanium Plus Enameled & durable inner container with high pressure withstanding capacity enabling long life & suitable for high rise buildings and pressure pump applications.
5. Multifunction Safety Valve (4 in 1)
  - a. Non return valve
  - b. Vacuum release valve
  - c. Pressure release valve
  - d. Drain valve
6. Compact size.
7. Drip proof construction.
8. CDR DLX PLUS Model comes with Thermostat knob & Temperature Indicator.

Knob: easy access temperature control knob for added convenience Analog thermal indicator: easy visual temperature indication to user.

## KNOW YOUR WATER HEATER:

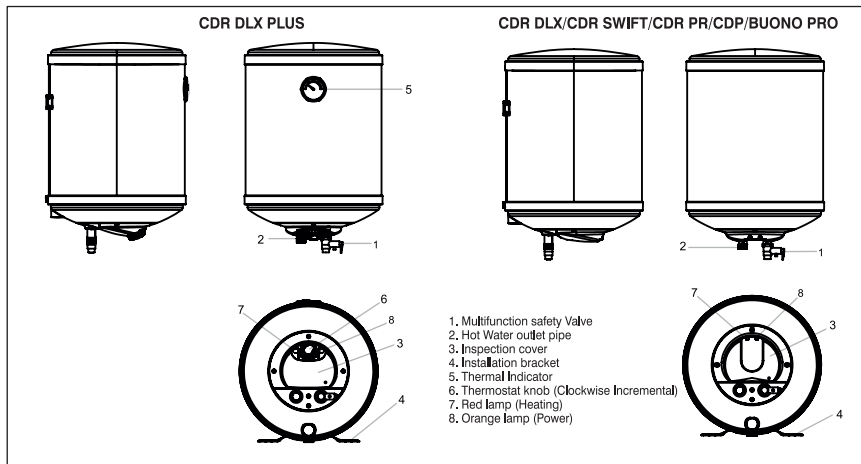

Fig. 1

## SAFETY DEVICES:

### A. Multi functional Safety Valve:

In-built multifunction safety valve (Pressure relief valve) is set to operate between 7.5 bar (109 p.s.i.) to 8.5 bar (123 p.s.i.).

Drain lever (L) is provided to drain the water heater only in case of servicing as shown in Fig.2 To avoid deposition of lime in the safety valve , please move the lever (L) up and down few times once in a 6 month .

Incase of safety-valve dripping during normal use, connect a discharge pipe (P) as shown in Fig.2. This will happen only if the pressure inside the tank reaches beyond rated pressure limits.



### A. Thermostat :

Hi-tech adjustable thermostat with automatic ON-OFF display and variable settings. The temperature of the thermostat can be adjusted by varying the knob position, The thermostat can be withdrawn without draining the water from water heater.

### B. Thermal Cutout :

Hi-tech thermal cutout non-self resetting type set to disconnect electrical connection in case of any fault occurs and/or the water temperature exceeds the present limit (this ensures extra safety). Please contact only authorized service personnel in such an event.

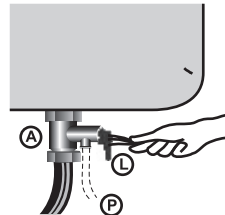

## SPECIFICATIONS

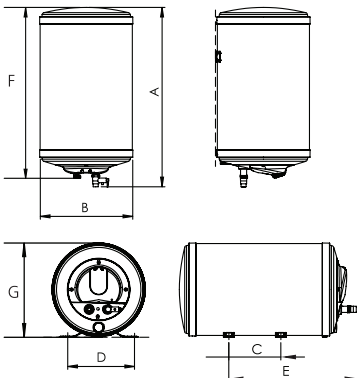

Fig.3

Models	A	B	C	D	E	F	G
CDR Swift 6V	438	290	-	212	287	408	300
CDR Swift 6H	459	290	145	-	307	408	300
CDR Dlx Plus/CDR Dlx CDR Swift/Buono Pro 10V	483	320	-	212	318	454	330
CDR Dlx Plus/CDR Dlx/CDR Swift 10H	504	320	145	-	376	454	330
CDR Dlx Plus/CDR Dlx/ CDR PR/CDP/Buono Pro 15V	605	320	-	212	456	576	330
CDR Dlx Plus/CDR Dlx/CDR PR/CDP 15H	626	320	178	212	546	576	330
CDR Dlx Plus/CDR Dlx/CDR Swift CDR PR /CDP/Buono Pro 25V	566	367	-	212	388	536	375
CDR Dlx Plus/CDR Dlx/CDR PR/CDP 25H	887	320	141	212	718	837	330
Cdr Dlx Plus/CDR Dlx/CDR PR 35V	706	367	-	212	528	676	375
CDR Dlx Plus/CDR Dlx/CDR PR 35H	726	367	295	212	548	676	375

All dimensions are in 'mm'

**Maximum rated pressure** - 8 Bar/ 800000 Pascal / 0.8 MPa/ 80 N/cm<sup>2</sup> /80m Water Head for CDR DLX Range models.

**Minimum inlet water pressure** - 5000 Pascal (0.05 bar) for all models

**Note:** Rated pressure is developed inside the tank after heating at outlet pipe. It is recommended to maintain approximately 1.5 bar pressure at inlet pipe.

## CDR SERIES

Model	CDR Swift						CDR Dix Plus/CDR DLX/CDR PR/CDP/BUONO PRO							
Capacity declared (Ltrs)	6V	6H	10V	10H	15V	25V	10V	10H	15V	15H	25V	25H	35V	35H
Real capacity (Ltrs)	6.1	6.4	10.2	10.4	15.3	25.1	10.2	10.4	15.3	15.6	25.1	25.7	35.4	35.1
Power supply (kw)	230Volts AC, 50, Single Phase													
Wattage(kw)	3kW						2kW							
Reheating time for 50°C temp rise (minutes) Max	10	15	25	40			20	30	50		65			
Mean hot water output temp (°C) Min	55°C						50°C							
Mixing factor (%) Max	10%	10%	20%				10%	20%		30%				

### PREPARATION FOR INSTALLATION:

1. For the installation of this water heater you need to prepare the wall suitably and more so if the wall is constructed out of hollow bricks.
2. For solid bricks the usual method of installation of drilling holes in the wall and securing bolts in the right position with the help of cement concrete can be adopted, use M8 x 75 mm bolts.
3. However for hollow bricks the following procedure should be adopted :
  - ⇒ Dig up sufficient space to accommodate the wall mounting bracket supplied with this water heater, up to a minimum depth of 80mm and fill up the complete space with cement concrete.
  - ⇒ After the cement concrete is properly set the wall bracket can then be secured to the wall with the help of bolts. It is very important to put the wall bracket only after the cement concrete has set in.

#### FOR VERTICAL INSTALLATION

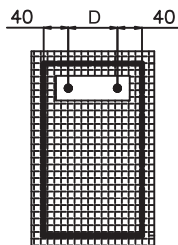

#### FOR HORIZONTAL INSTALLATION

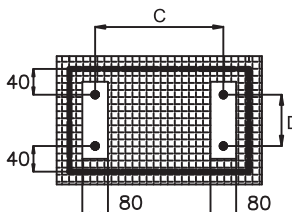

Fig. 4

### INSTALLATION

#### Mounting and Plumbing

1. Mounting bracket is supplied with the water heater.
2. Mark the position of the bolts on the wall, after checking the same with the mounting bracket supplied with the water heater.
3. Hook the water heater to the bolts and pull down the water heater slightly by hand to cause firm gripping in the slot of the bracket.
4. The cold water inlet pipe is circled with a blue collar while the hot water outlet pipe with red collar.
5. Fix 1/2" BSP union coupling on inlet and outlet connections.
6. Make necessary plumbing with the reference of the installation diagrams shown.
7. Ensure proper ventilation where the water heater unit is been installed.

For a horizontal **wall** mounting right hand side plumbing arrangement, the inlet/outlet pipes are on the right hand side when viewed from the front. The inlet pipe is below the outlet pipe. (Fig. 5b).  
 For a horizontal **wall** mounting left hand side plumbing arrangement, the inlet/outlet pipes are on the left hand side when viewed from the front. The inlet pipe is below the outlet pipe in this configuration as well. (Fig. 5d) Please ensure to mount the horizontal wall mounting product in correct configuration.

Please ensure that the pressure in the water heater is less than the rated pressure. Install pressure reducing valve at the inlet as shown in Fig. 5.

**VERTICAL PLUMBING**

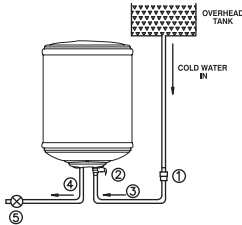

**Fig. 5a**

**HORIZONTAL PLUMBING (WALL-MOUNTING)-RHS**

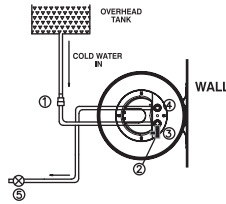

**Fig. 5b**

**HORIZONTAL PLUMBING (FLOOR-MOUNTING)-RHS**

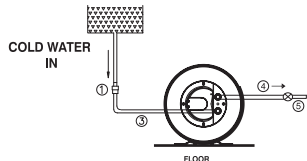

**Fig. 5c**

**HORIZONTAL PLUMBING (WALL-MOUNTING)-LHS**

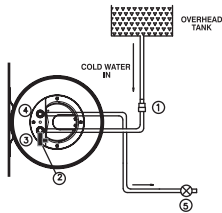

**Fig. 5d**

1. Pressure Reducing Valve (PRV)
2. Multi-function safety valve (MFSV)
3. Cold water Inlet
4. Hot water outlet
5. Stop Cock (SC)

PRV should be installed at a minimum distance of 12 feet from the inlet pipe, to avoid safety valve dripping.

**PLASTIC CONNECTOR ASSY INSTRUCTIONS :**

**VERTICAL PRODUCT**

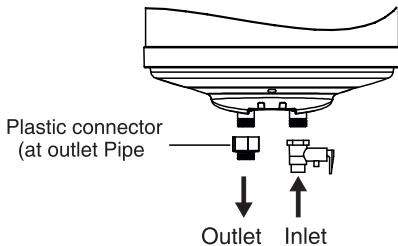

**HORIZONTAL PRODUCT**

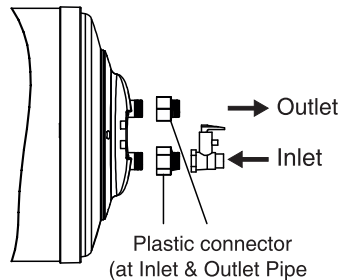

**NOTES :**

1. Polybag containing plastic connector/s and sealing washer/s placed in Thermocol packaging.
2. Recommended to use plastic connector/s to avoid thermal loss for better energy savings.

## MAINS CORD:

- 3 Core X 1.0 Sq.mm (32/0.2) PVC Sheathed core with ISI certified for CDR Dlx Plus, CDR Dlx, CDR PR, Buono Pro & CDP (2Kw) models.
- 3 Core X 1.5 Sq. mm (48/0.2) PVC Sheathed core with ISI certified for CDR Swift (3Kw) models.

## ELECTRICAL CONNECTION:

Refer wiring diagram, Fig.6 to check electrical connections. Ensure proper earthing at 3pin supply point.

## WIRING DIAGRAM CDR Series:

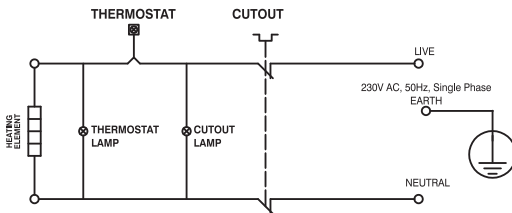

Fig. 6

**Note:** Main's cord or any other electrical component must be repaired /replaced by authorized service personnel only. Minimum Contact separation of 3mm is required in all poles for disconnection.

## GUIDELINE TO CONVERT CDR DLX PRODUCT FROM WM TO FM

Follow the below procedure to convert wall mounting (WM) product to floor mounting (FM).

1. Take wall mounting product & remove both bracket by unscrewing M6 bolts using Spanner.
2. Take the accessory kit of respective product & remove external converters from poly bag. Unscrew the M6 nuts & washers of External Converter. Fix the above removed wall mounting bracket on external converter by screwing the M6 washer & nut again as shown in picture below.
3. Fix this external converter to wall mounting product as shown in picture below by screwing M6 bolts. Rest the product on floor to check product balance & set product by adjusting either of the brackets. Mark center to center distance of bracket & fix the product by anchor bolts.

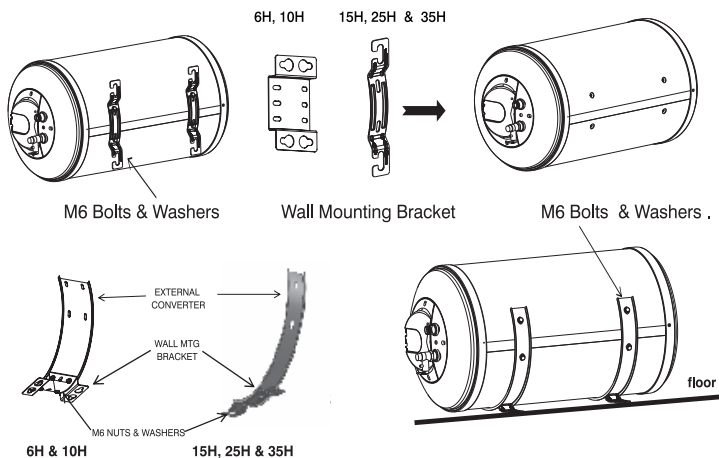

## TROUBLE SHOOTING GUIDE FOR WATER HEATER:

#	Problem/Observation	Possible causes	Solution /Remarks
1	Water Heating takes longer time than specified in Instruction manual	Scaling on the Heating element cause slower water heating	Get the Heating element de-scaled from authorized service person or replace with genuine spare parts recommended by company  Measure the temperature of water using thermometer. Adjust the flow rate at 3 Ltrs/min
		Low voltage at certain places	Check the voltage at customer's place
2	Equipment creates abnormal Noise	High voltage fluctuations ,Hard water	Recommend Spare Heating element with low watt density (8W/cm <sup>2</sup> )
	Equipment creates hissing Noise	Due to scaling on Heating Element	descaling Heating element
3	Unit not working	Power point may not be working	Need the line at customer's place to be checked
		Check for any short circuit of harness/Power cord inside	
		Cut out operated due to dry heating	Reset Cut out
		Heating element might not be functioning (may be due to Dry heat or short/Crack/burst/heavy scaling)	Replace Heating element
4	Leakage of the unit	Rusting of the tank	Check from where the leakage is (tank, collar, gasket, Heater plate), Replace or repair based on the observation
		Not enough torque to the bolts on HP/HE flange	Replace or repair based on the observation
		Leaking from Heating element brass flange (Instant water heater)	Replace Heating element
5	No Hot water out put	Heating element not working	Reset Cut out
		Thermostat low setting (check if someone tampered the setting in Instant water heater)	
		Cut out trip	
		Inlet valve closed	Open the inlet valve
6	User gets mild shock when using Water heater	Improper earthing at customer's place	Check for proper earthing & if not then suggest customer to do it properly
7	Outlet water blockage	Heavy scaling on Outlet pipe opening end	descaling the product from authorized service personal
8	Leaking from MFSV (Safety valve)	Excess pressure than rated pressure	Check the pressure when unit is in ON condition, ensure Inlet line is ON.  <b>Note</b> When MFSV is dripping, it ensures safety of the equipment from excess pressure. Put drain pipe at MFSV with clip .
		Check NRV/PRV position from inlet pipe	It should be minimum 12 feet from equipment
		Check if PRV is there in inlet water line (Specially in multi storey building)	Install pressure reducing valve (PRV), if inlet water pressure is more than 1.5 bar, specially in multi storey building.
9	Water Heater unit burnt	Short circuit of the harness/Power Cord	Replace Harness asm or Power Cord
		Use of Low amp Power Cord	Use only Racold specified power cord.
10	Smell comes out of water	If water Heater unit is not used in 15+ days, water inside smells for some time	Flush out 2 times capacity of water heater



## DO's AND DON'Ts OF WATER HEATER:

#	DO's.	REMARKS
1	Installation of water heater should be done by qualified person only, preferably from Racold service.	Product warranty will get void in case of wrong installation.
2	Use pressure reducing valve in case rated water pressure is higher than recommended.	To Avoid Water dripping from safety valve.
3	Inlet water line should be continuously Open when water heater is in use except when it is being serviced.	
4	Ensure proper leveling of the unit while doing installation.	If tilted, it may affect the hot water output quantity .
5	Ensure proper earthing at the place of Installation.	Chances of getting Shock.
6	Use ISI marked or Branded company Power Plugs only.	Use 16 Amp Power Plug only.
7	Use of two spanners suggested while Installing the product (connecting the hose pipes)	There may be a chance of crack on the pipes if we don't do so
8	Ensure water coming out from outlet prior switching the unit ON (first time)	If no water inside tank, unit goes into dry heat causing damages, burning etc. else Warranty will be void.
9	It is recommended that the IN/OUT pipes, Heating Element and Safety valve be de-scaled at least once in 6 months through proper Racold service only. "At customer cost"	This helps In Improving product life.
10	As per the safety norms Thermostat, cut out are set at desired temperatures and Safety Valve set at desired pressure and its recommended not to change the settings.	Product warranty will get void if setting changed.
11	Power OFF the unit while servicing the water heater unit.	Chances of product burning/Safety purpose
12	Use Only Genuine company spare parts from authorised service centers.	Product warranty will get void if used other than company recommended spare parts.
#	DON'Ts	REMARKS
1	Use connectors in case if it is required to connect another cord with main power cord came along with the product.	Chances of product burning /Safety purpose
2	Do not tamper the thermostat setting.	As per safety standards, thermostats are set at desired temperatures. Recommend not to change the settings.
3	Do not switch ON the product without checking the water coming out from outlet.	Chances of product burning.
4	Do not adjust/disturb Safety valve setting.	As per safety standards, Safety valve are set at desired pressure. Recommend not to change the settings.

## IMPORTANT NOTES:

- Optimum hot water performance is achieved when water flow kept at 3 LPM (litre per minute)
- Optimum performance of the water heater is achieved when the total hardness of water <400 ppm & chloride content <300 ppm.
- In case a pressure reducing valve/NRV is used in installation, please ensure that it is installed at a min. 12 feet distance from the inlet point.
- Please ensure the installation of water heater to be done by keeping minimum 1 foot from the wall on either side.
- Anode should be checked periodically within 6 months. If found consumed (< Dia.7mm), replace it on chargeable basis.
- If product installed at inaccessible place, it is customer's responsibility to dismount the product and make available to the service representative.
- Annual maintenance contract (AMC)- it is recommended to take AMC and extended warranty from authorized service franchisee.
- Visit charges shall be applicable for product Installation, Demonstration & explanation related calls.
- Please ensure proper ventilation whenever the unit is installed to avoid any rust formation/aggravation.

# ELECTRIC WATER HEATER INSTALLATION GUIDELINE FOR PLUMBERS

- Read Instruction Manual carefully and follow installation instructions.
- Safety valve are pre-set for certain working pressure. Under any circumstances do not tamper/over-tighten the safety valve.
- Continuous water dripping from Safety valve is an indication of excessive pressure at inlet of water heater compared to rated pressure. In that case install pressure reducing valve at the inlet.
- Check for leakage after installation, Plumbing & before switching ON the power supply.
- Ensure flow of water from outlet before connecting electric power supply to the appliance.
- Do not use excessive force while tightening inlet and outlet Couplings. This may cause serious damage to the water heater. Use Cross spanner for tightening
- Check supply voltage at the place of installation 230V.
- Ensure proper earthing of electrical connection.
- No extension cords to be used.
- Use only ISI marked electrical accessories of proper rating e.g. 3 pin Plug, Connection Boxes, Wires etc.
- In water heaters, check whether both blue and red lamps are glowing when the water heater is switched on.
- Ensure all couplings/Joints are leak proof.
- Check the water Heater operation for one complete cycle e.g one cycle of Thermostat operation. i.e. Cut off and Cut-in.



Red



Blue/Orange



## Warranty Card

**2** YEAR  
**WARRANTY**

**PLEASE COMPLETE THE FOLLOWING DETAILS:**

**Product:** ELECTRIC STORAGE WATER HEATER \_\_\_\_\_

**Model No:** \_\_\_\_\_ **Serial No:** \_\_\_\_\_

**PURCHASER'S NAME & ADDRESS:** \_\_\_\_\_

**DEALER'S NAME & ADDRESS:** \_\_\_\_\_

**DEALER'S SIGNATURE:** \_\_\_\_\_

**CASH MEMO NO:** \_\_\_\_\_

**DATE OF PURCHASE:** \_\_\_\_\_

The Racold water heater comes with warranty period of 2 years from the date of purchase against electrical or mechanical failure due to defective material and workmanship. The Inner container has warranty of 7 years for CDR Dix Plus & CDR DLX, 5 years for CDR PR, CDR Swift, CDP & Buono Pro models . The heating elements has a warranty of 3 years for CDR Dix plus models only & other models carry 2 years warranty for Heating elements. In event of failure covered by this warranty, you are requested to contact our customer care and obtain the complaint number. Our trained technicians will repair the product at our nation .No further liability for the consequential or damages caused due to improper use. All disputed will be subjected to Pune Jurisdiction only . The warranty on the tank includes the tank only. It does not include any other parts inside or outside of the tank.

**Warranty on the tank and heating element applies only if:**

- 1) Annual check af anode ls done mandatorily & Its replacement done Incase of consumption (rod dia less than 7mm).
- 2) Warranty will be no more valid in case the maintenance of anode is not done as per point no. 1.

**Following things shall not be covered under warranty:**

- 1) Any plumbing and/or Electrical related problems, not related to product.
- 2) Any defects arising due to wrong and/or non recommended installation procedure.
- 3) Dry heating of water heater.
- 4) Consumables such as anode.
- 5) Any human injury, property damages and consequential damages caused due to improper use.

It is recommended to install the product through the authorized service centre.



**Additional Note:** To prevent issues related to CPVC/UPVC, please ensure to verify the suitability of CPVC/UPVC plumbing for water heater installation. Use only if deemed appropriate after confirming compatibility.



Ariston Group India Private Limited

1st Floor, Office No. 103, Mayfair Tower, Wakdedwadi, Shivajinagar Pune - 411005, Maharashtra, India.

Customer care number (9 am to 9 pm):

020 6734 2288, +91 8600 25 6000 | 7362 888 999  |  Email: customer.care@racold.com

www.racold.com



Your comfort your way

# REBORN EVERYDAY WITH HOT WATER



[www.racold.com](http://www.racold.com)

## QUICK START :

1. Connect the safety valve at the inlet of water heater if supplied separately. Don't install water heater without safety valve.
2. Hook the water heater on wall with the help of mounting brackets. Take Necessary dimensions for making holes for mounting brackets.
3. Connect the inlet & outlet piping as marked on water heater.
4. Start water flow inside Water heater & fill it completely till water comes out from outlet connection.
5. Connect the electrical cord to power point.
6. Switch on the water heater's main supply, red indicator lamp comes on.
7. The red indicator lamp switches off indicates water inside the water heater reached to the set temperature
8. Run a complete cycle of Thermostat ON to Thermostat cut OFF, in presence of service provider / Installation technician / plumber.

Ariston Group India Private Limited

1st Floor, Office No. 103, Mayfair Tower, Wakdewadi, Shivajinagar Pune - 411005, Maharashtra, India.



Customer care number (9 am to 9 pm):

020 6734 2288, +91 8600 25 6000



7362 888 999



Email: [customer.care@racold.com](mailto:customer.care@racold.com)

[www.racold.com](http://www.racold.com)